



Filter regulators LFR/LFRS, D series



Filter regulators LFR/LFRS, D series, metal design

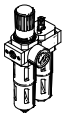
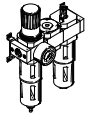
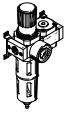

Product range overview D series service units, metal design

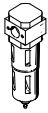
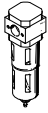
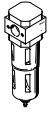
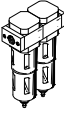
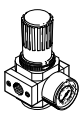
Type	Size	Pneumatic connection										Pressure regulation range [bar]			Grade of filtration [µm]			
		M5	M7	G1/8	G1/4	G3/8	G1/2	G3/4	G1	QS4	QS6	0.5 ...	0.5 ...	2.5 ...	0.01	1	5	40
Service units																		
FRC/FRCS 	Micro	■	■	■	-	-	-	-	-	■	■	■	-	-	-	-	■	-
	Mini	-	-	■	■	■	-	-	-	-	-	■	■	-	-	-	■	■
	Midi	-	-	-	■	■	■	■	-	-	-	■	■	-	-	-	■	■
	Maxi	-	-	-	-	-	■	■	■	-	-	■	■	-	-	-	■	■
FRC-K 	Micro	-	-	-	-	-	-	-	-	-	-	-	-	-	-	-	-	
	Mini	-	-	■	■	-	-	-	-	-	-	-	■	■	-	-	-	■
	Midi	-	-	-	■	■	■	-	-	-	-	-	■	■	-	-	-	■
	Maxi	-	-	-	-	-	■	■	-	-	-	-	■	■	-	-	-	■
LFR-K LFRS-K 	Micro	-	-	-	-	-	-	-	-	-	-	-	-	-	-	-	-	
	Mini	-	-	■	■	-	-	-	-	-	-	-	■	■	-	-	-	■
	Midi	-	-	-	■	■	■	-	-	-	-	-	■	■	-	-	-	■
	Maxi	-	-	-	-	-	■	■	-	-	-	-	■	■	-	-	-	■
Individual devices																		
Filter regulators LFR/LFRS 	Micro	■	■	■	-	-	-	-	-	■	■	■	-	-	-	-	■	-
	Mini	-	-	■	■	■	-	-	-	-	-	■	■	-	-	-	■	■
	Midi	-	-	-	■	■	■	■	-	-	-	■	■	-	-	-	■	■
	Maxi	-	-	-	-	-	■	■	■	-	-	■	■	-	-	-	■	■
Filters LF 	Micro	■	■	■	-	-	-	-	-	■	■	-	-	-	-	-	■	-
	Mini	-	-	■	■	■	-	-	-	-	-	-	-	-	-	-	■	■
	Midi	-	-	-	■	■	■	■	-	-	-	-	-	-	-	-	■	■
	Maxi	-	-	-	-	-	■	■	■	-	-	-	-	-	-	-	■	■
Fine and micro filters LFMA/LFMB 	Micro	-	-	-	-	-	-	-	-	-	-	-	-	-	-	-	-	
	Mini	-	-	■	■	■	-	-	-	-	-	-	-	-	■	■	-	-
	Midi	-	-	-	■	■	■	■	-	-	-	-	-	-	■	■	-	-
	Maxi	-	-	-	-	-	■	■	■	-	-	-	-	-	■	■	-	-
Active carbon filters LFX 	Micro	-	-	-	-	-	-	-	-	-	-	-	-	-	-	-	-	
	Mini	-	-	■	■	■	-	-	-	-	-	-	-	-	-	-	-	-
	Midi	-	-	-	■	■	■	■	-	-	-	-	-	-	-	-	-	-
	Maxi	-	-	-	-	-	■	■	■	-	-	-	-	-	-	-	-	-
Filter combinations LFMBA 	Micro	-	-	-	-	-	-	-	-	-	-	-	-	-	-	-	-	
	Mini	-	-	■	■	■	-	-	-	-	-	-	-	-	■	■	-	-
	Midi	-	-	-	■	■	■	■	-	-	-	-	-	-	■	■	-	-
	Maxi	-	-	-	-	-	■	■	■	-	-	-	-	-	■	■	-	-
Pressure regulators LR/LRS 	Micro	■	■	■	-	-	-	-	-	■	■	■	-	-	-	-	-	
	Mini	-	-	■	■	■	-	-	-	-	-	■	■	-	-	-	-	
	Midi	-	-	-	■	■	■	■	-	-	-	■	■	-	-	-	-	
	Maxi	-	-	-	-	-	■	■	■	-	-	■	■	-	-	-	-	

Filter regulators LFR/LFRS, D series, metal design

Product range overview D series service units, metal design

Type	Size	Bowl guard		Condensate drain			Pressure indication		Actuator lock		Supply voltage			Options			→ Page/ Internet
		Metal bowl guard	Plastic bowl	Manual rotary	Semi-automatic	Fully automatic	With pressure gauge	Without pressure gauge	Rotary knob with detent	Rotary knob with integrated lock	24 V DC	110 V AC	230 V AC	Directly actuated pressure regulator with integrated return flow function	Pilot actuated pressure regulator with integrated return flow function	Differential pressure indicator	
Service units																	
FRC/FRCS	Micro	-	■	■	■	-	■	■	■	-	-	-	-	-	-	-	frc
	Mini	■	-	■	-	■	■	■	■	■	-	-	-	-	-	-	
	Midi	■	-	■	-	■	■	■	■	■	-	-	-	-	-	-	
	Maxi	■	-	■	-	■	■	■	■	■	-	-	-	■	■	-	
FRC-K	Micro	-	-	-	-	-	-	-	-	-	-	-	-	-	-	-	frc
	Mini	■	-	■	-	■	■	-	■	-	■	-	-	-	-	-	
	Midi	■	-	■	-	■	■	-	■	-	■	-	-	-	-	-	
	Maxi	■	-	■	-	■	■	-	■	-	■	-	-	■	■	-	
LFR-K LFRS-K	Micro	-	-	-	-	-	-	-	-	-	-	-	-	-	-	-	lfr
	Mini	■	-	■	-	■	■	-	■	■	■	-	-	-	-	-	
	Midi	■	-	■	-	■	■	-	■	■	■	-	-	-	-	-	
	Maxi	■	-	■	-	■	■	-	■	■	■	-	-	■	■	-	
Individual devices																	
Filter regulators LFR/LFRS	Micro	-	■	■	■	-	■	■	■	-	-	-	-	-	-	-	6
	Mini	■	-	■	-	■	■	■	■	■	-	-	-	-	-	-	
	Midi	■	-	■	-	■	■	■	■	■	-	-	-	-	-	-	
	Maxi	■	-	■	-	■	■	■	■	■	-	-	-	■	■	-	
Filters LF	Micro	-	■	■	■	-	-	-	-	-	-	-	-	-	-	-	lf
	Mini	■	-	■	-	■	-	-	-	-	-	-	-	-	-	-	
	Midi	■	-	■	-	■	-	-	-	-	-	-	-	-	-	-	
	Maxi	■	-	■	-	■	-	-	-	-	-	-	-	-	-	-	
Fine and micro filters LFMA/LFMB	Micro	-	-	-	-	-	-	-	-	-	-	-	-	-	-	-	lfma, lfmb
	Mini	■	-	■	-	■	-	-	-	-	-	-	-	-	-	■	
	Midi	■	-	■	-	■	-	-	-	-	-	-	-	-	-	■	
	Maxi	■	-	■	-	■	-	-	-	-	-	-	-	-	-	■	
Active carbon filters LFX	Micro	-	-	-	-	-	-	-	-	-	-	-	-	-	-	-	lfx
	Mini	■	-	-	-	-	-	-	-	-	-	-	-	-	-	-	
	Midi	■	-	-	-	-	-	-	-	-	-	-	-	-	-	-	
	Maxi	■	-	-	-	-	-	-	-	-	-	-	-	-	-	-	
Filter combinations LFMBA	Micro	-	-	-	-	-	-	-	-	-	-	-	-	-	-	-	lfmba
	Mini	■	-	■	-	■	-	-	-	-	-	-	-	-	-	■	
	Midi	■	-	■	-	■	-	-	-	-	-	-	-	-	-	■	
	Maxi	■	-	■	-	■	-	-	-	-	-	-	-	-	-	■	
Pressure regulators LR/LRS	Micro	-	-	-	-	-	■	■	■	-	-	-	-	-	-	-	lr
	Mini	-	-	-	-	-	■	■	■	■	-	-	-	■	-	-	
	Midi	-	-	-	-	-	■	■	■	■	-	-	-	■	-	-	
	Maxi	-	-	-	-	-	■	■	■	■	-	-	-	■	■	-	

Filter regulators LFR/LFRS, D series, metal design



Product range overview D series service units, metal design

Type	Size	Pneumatic connection										Pressure regulation range [bar]		
		M5	M7	G1/8	G1/4	G3/8	G1/2	G3/4	G1	QS4	QS6	0.5 ... 7	0.5 ... 12	
Individual devices														
Pressure regulators LRB/LRBS		Micro	-											
		Mini	-	-	-	■	-	-	-	-	-	-	■	■
		Midi	-	-	-	-	■	-	-	-	-	-	■	■
		Maxi	-											
Pressure regulator combinations LRB-K		Micro	-											
		Mini	-	-	-	■	■	-	-	-	-	-	■	■
		Midi	-	-	-	-	■	■	-	-	-	-	■	■
		Maxi	-											
Lubricators LOE		Micro	■	■	■	-	-	-	-	-	■	■	-	-
		Mini	-	-	■	■	■	-	-	-	-	-	-	-
		Midi	-	-	-	■	■	■	■	-	-	-	-	-
		Maxi	-	-	-	-	-	■	■	■	-	-	-	-
On-off valves HE		Micro	-											
		Mini	-	-	■	■	■	-	-	-	-	-	-	-
		Midi	-	-	-	■	■	■	■	-	-	-	-	-
		Maxi	-	-	-	-	-	■	■	■	-	-	-	-
On-off valves, electrical HEE		Micro	-											
		Mini	-	-	■	■	■	-	-	-	-	-	-	-
		Midi	-	-	-	■	■	■	■	-	-	-	-	-
		Maxi	-	-	-	-	-	■	■	■	-	-	-	-
On-off valves, pneumatic HEP		Micro	-											
		Mini	-	-	■	■	■	-	-	-	-	-	-	-
		Midi	-	-	-	■	■	■	■	-	-	-	-	-
		Maxi	-	-	-	-	-	■	■	■	-	-	-	-
Soft-start valves HEL		Micro	-											
		Mini	-	-	■	■	■	-	-	-	-	-	-	-
		Midi	-	-	-	■	■	■	■	-	-	-	-	-
		Maxi	-	-	-	-	-	■	■	■	-	-	-	-
Membrane air dryers LDM1		Micro	-											
		Mini	-											
		Midi	-											
		Maxi	-	-	-	-	-	■	■	■	-	-	-	-
Branching modules FRM		Micro	-											
		Mini	-	-	■	■	■	-	-	-	-	-	-	-
		Midi	-	-	-	■	■	■	■	-	-	-	-	-
		Maxi	-	-	-	-	-	■	■	■	-	-	-	-
Distributor block FRZ		Micro	-											
		Mini	-											
		Midi	-											
		Maxi	-											

Filter regulators LFR/LFRS, D series, metal design

Product range overview D series service units, metal design

Type	Size	Bowl guard		Pressure indication		Actuator lock		Supply voltage			Options		→ Page/ Internet
		Metal bowl guard	Plastic bowl	With pressure gauge	Without pressure gauge	Rotary knob with detent	Rotary knob with integrated lock	24 V DC	110 V AC	230 V AC	Non-return function	Pressure switch	
Individual devices													
Pressure regulators LRB/LRBS	Micro	-	-	-	■	■	■	-	-	-	-	-	lrb
	Mini	-	-	-	■	■	■	-	-	-	-	-	
	Midi	-	-	-	■	■	■	-	-	-	-	-	
	Maxi	-	-	-	■	■	■	-	-	-	-	-	
Pressure regulator combinations LRB-K	Micro	-	-	-	■	■	-	-	-	-	-	-	lrb
	Mini	-	-	-	■	■	-	-	-	-	-	-	
	Midi	-	-	-	■	■	-	-	-	-	-	-	
	Maxi	-	-	-	■	■	-	-	-	-	-	-	
Lubricators LOE	Micro	-	■	-	■	-	-	-	-	-	-	-	loe
	Mini	■	-	-	■	-	-	-	-	-	-	-	
	Midi	■	-	-	■	-	-	-	-	-	-	-	
	Maxi	■	-	-	■	-	-	-	-	-	-	-	
On-off valves HE	Micro	-	-	-	■	■	-	-	-	-	-	-	he
	Mini	-	-	-	■	■	-	-	-	-	-	-	
	Midi	-	-	-	■	■	-	-	-	-	-	-	
	Maxi	-	-	-	■	■	-	-	-	-	-	-	
On-off valves, electrical HEE	Micro	-	-	-	■	-	-	■	■	■	-	-	hee
	Mini	-	-	-	■	-	-	■	■	■	-	-	
	Midi	-	-	-	■	-	-	■	■	■	-	-	
	Maxi	-	-	-	■	-	-	■	■	■	-	-	
On-off valves, pneumatic HEP	Micro	-	-	-	■	-	-	-	-	-	-	-	hep
	Mini	-	-	-	■	-	-	-	-	-	-	-	
	Midi	-	-	-	■	-	-	-	-	-	-	-	
	Maxi	-	-	-	■	-	-	-	-	-	-	-	
Soft-start valves HEL	Micro	-	-	-	■	-	-	-	-	-	-	-	hel
	Mini	-	-	-	■	-	-	-	-	-	-	-	
	Midi	-	-	-	■	-	-	-	-	-	-	-	
	Maxi	-	-	-	■	-	-	-	-	-	-	-	
Membrane air dryers LDM1	Micro	-	-	-	■	-	-	-	-	-	-	-	ldm1
	Mini	-	-	-	■	-	-	-	-	-	-	-	
	Midi	-	-	-	■	-	-	-	-	-	-	-	
	Maxi	■	-	-	■	-	-	-	-	-	-	-	
Branching modules FRM	Micro	-	-	-	■	-	-	-	-	-	■	■	frm
	Mini	-	-	-	■	-	-	-	-	-	■	■	
	Midi	-	-	-	■	-	-	-	-	-	■	■	
	Maxi	-	-	-	■	-	-	-	-	-	■	■	
Distributor block FRZ	Micro	-	-	-	■	-	-	-	-	-	-	-	frz
	Mini	-	-	-	■	-	-	-	-	-	-	-	
	Midi	-	-	-	■	-	-	-	-	-	-	-	
	Maxi	-	-	-	■	-	-	-	-	-	-	-	

Filter regulators LFR/LFRS, D series, metal design

Peripherals overview

Micro

Individual unit with connection plates,
connection size G $\frac{1}{8}$, QS-4 or QS-6

Individual unit without connection plates, for service unit combination
connection thread M5 or M7 in housing

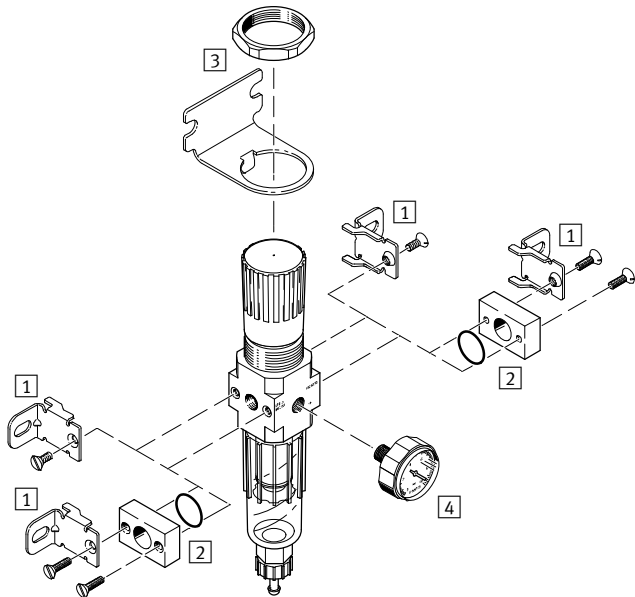
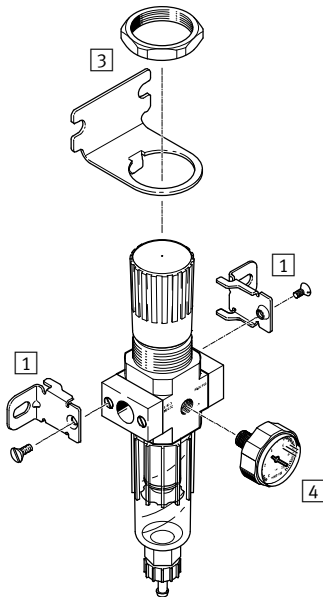

Mounting attachments and accessories					
	Individual unit		Combination		→ Page/ Internet
	with connection plates	without connection plates	with connection plates	without connection plates	
1	Mounting bracket HFOE	■	■	■	hfoe-d
2	Connecting plate kit PBL	-	■	-	pbl
3	Mounting bracket HRS	■	■	■	hrs-d
4	Pressure gauge MA-27	■	■	■	32

Filter regulators LFR/LFRS, D series, metal design

Peripherals overview



Mini/Midi/Maxi

Filter regulator LFR

Filter regulator LFRS, lockable

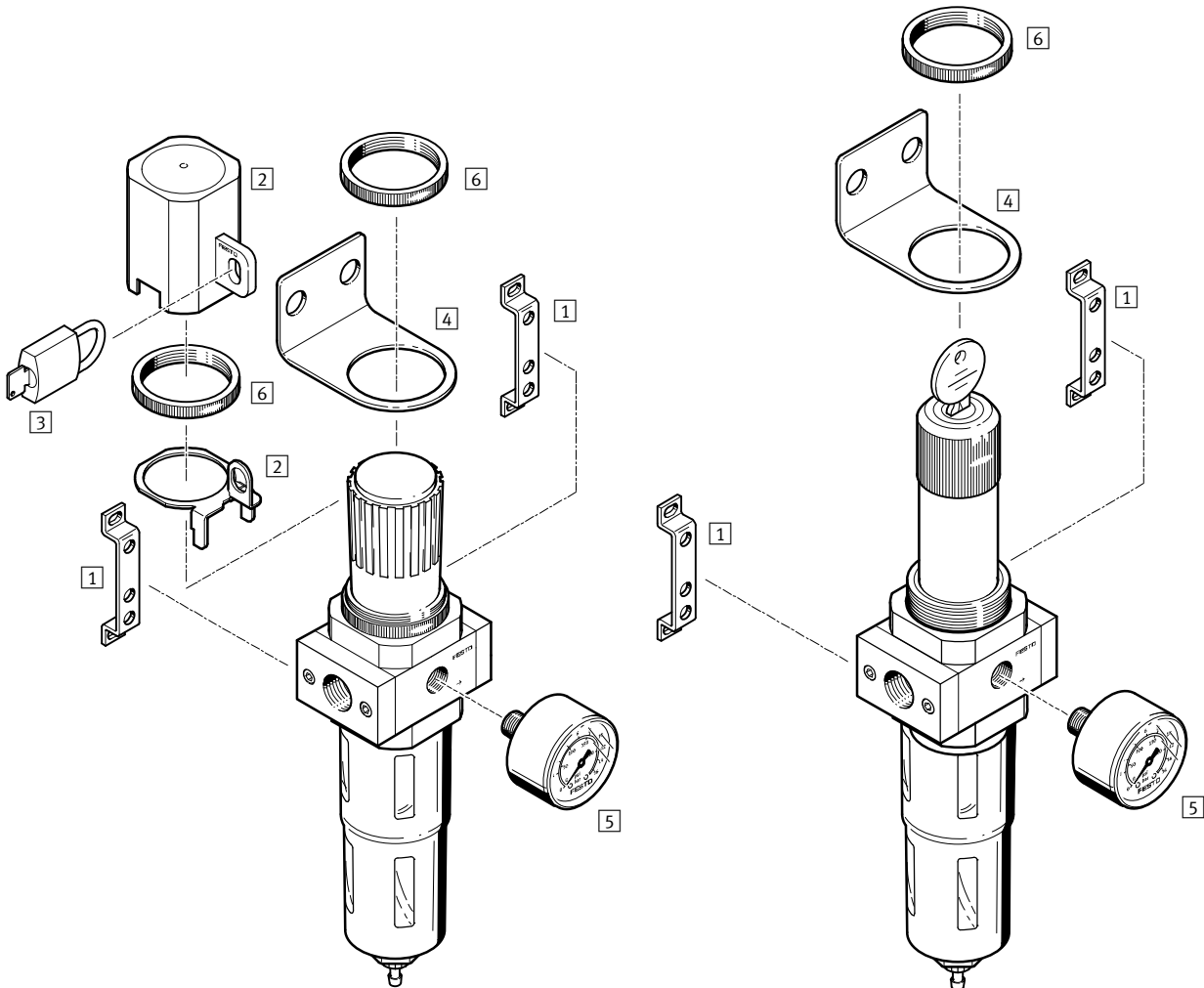

Mounting attachments and accessories

	Rotary knob with detent	Rotary knob, lockable	→ Page/ Internet
1 Mounting bracket HFOE	■	■	hfoe-d
2 Regulator lock LRVS	■	-	lrvs-d
3 Padlock LRVS-D	■	-	lrvs-d
4 Mounting bracket HR-D	■	■	hr-d
5 Pressure gauge MA	■	■	32
6 Knurled nut (included in scope of delivery) HMR	■	■	-

Filter regulators LFR/LFRS, D series, metal design

Type codes

LFR - 3/8 - D - 7 - 0 - MIDI - A

Basic function

LFR	Filter regulator
LFRS	Filter regulator, lockable

Pneumatic connection

MICRO (LFR only)	
M5	Connecting thread M5 in housing
M7	Connecting thread M7 in housing
1/8	Connecting plates with connecting thread G1/8
QS4	Connecting plates with push-in connector QS-4
QS6	Connecting plates with push-in connector QS-6
MINI	
1/8	Connecting plates with connecting thread G1/8
1/4	Connecting plates with connecting thread G1/4
3/8	Connecting plates with connecting thread G3/8
MIDI	
1/4	Connecting plates with connecting thread G1/4
3/8	Connecting plates with connecting thread G3/8
1/2	Connecting plates with connecting thread G1/2
3/4	Connecting plates with connecting thread G3/4
MAXI	
1/2	Connecting plates with connecting thread G1/2
3/4	Connecting plates with connecting thread G3/4
1	Connecting plates with connecting thread G1

Series

D	Series
---	--------

Pressure regulation range

7	0.5 ... 7 bar
	0.5 ... 12 bar

Grade of filtration

	40 µm
5M	5 µm

Pressure gauge

	With pressure gauge
0	Without pressure gauge

Function (optional)

DI	Directly actuated pressure regulator with integrated return flow function (MAXI only)
----	---

Size

MICRO	Grid dimension 25 mm (without connecting plates)
MINI	Grid dimension 40 mm (without connecting plates)
MIDI	Grid dimension 55 mm (without connecting plates)
MAXI	Grid dimension 66 mm (without connecting plates)

Condensate drain

	Turned manually
H	Semi-automatic
A	Fully automatic

Filter regulators LFR/LFRS, D series, metal design

Technical data

LFR/LFRS

Manual rotary condensate drain, with pressure gauge

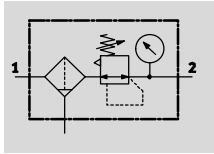

Semi or fully automatic condensate drain, with pressure gauge

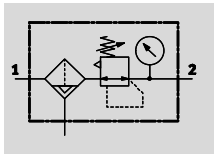

LFR/LFRS-...-DI-MAXI

Manual rotary condensate drain, with pressure gauge

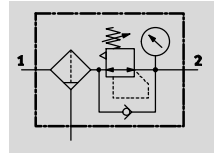

Fully automatic condensate drain, with pressure gauge

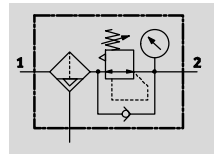

- - Flow rate
110 ... 11,000 l/min
- - Temperature range
-10 ... +60 °C
- - Operating pressure
1 ... 16 bar

- Space-saving design with filter and regulator in a single unit
- Good particle separation and high flow rate
- Good regulating characteristics with minimal hysteresis

- Two pressure regulation ranges: 0.5 ... 7 bar and 0.5 ... 12 bar
- Two pressure gauge connections for flexible installation
- Setting values are secured by locking the rotary knob

- With manual, semi-automatic or fully automatic condensate drain
- Choice of filter cartridges: 5 µm or 40 µm
- New filter cartridges → 31
- Pressure sensor (optional) → 32

General technical data				
Size	Micro	Mini	Midi	Maxi
Pneumatic connection 1, 2 ¹⁾	M5 ²⁾ , M7 ²⁾ , G1/8, QS-4 ³⁾ , QS-6 ³⁾	G1/8, G1/4, G3/8	G1/4, G3/8, G1/2, G3/4	G1/2, G3/4, G1
Design	Filter regulator with/without pressure gauge			
Type of mounting	Via accessories In-line installation			
Assembly position	Vertical ±5°			
Grade of filtration [µm]	5	5 40		
Air purity class at the output	Compressed air according to ISO 8573-1:2010 [6:8:4] (grade of filtration 5 µm)			
	Compressed air according to ISO 8573-1:2010 [7:8:4] (grade of filtration 40 µm)			
	Inert gases			
Bowl guard	- Metal bowl guard			
Condensate drain	Manual rotary Semi-automatic Fully automatic			
Regulator lock	Rotary knob with detent - Rotary knob with integrated lock			
Pressure regulation range [bar]	0.5 ... 7	0.5 ... 7 0.5 ... 12		
Max. hysteresis [bar]	0.3	0.2		0.4
Pressure indication	Via pressure gauge M5 prepared G1/8 prepared G1/4 prepared G1/2 prepared			
Max. condensate volume [cm ³]	3	22	43	80 ⁴⁾

1) Connecting plates with connecting thread
 2) Without connecting plates, connecting thread in housing
 3) Connecting plates with push-in connector
 4) The max. condensate volume for the LFR/LFRS-...-DI-MAXI is 43 cm³.
 - - Note: This product conforms to ISO 1179-1 and to ISO 228-1

Filter regulators LFR/LFRS, D series, metal design

Technical data

Standard nominal flow rate $q_{mN}^{1)}$ [l/min]						
Size	Micro					
Pneumatic connection 1, 2	M5	M7	G $\frac{1}{8}$	QS-4	QS-6	
Pressure regulation range	0.5 ... 7 bar	110	280	410	150	410

- 1) Measured at $p_1 = 10$ bar, $p_2 = 6$ bar and $\Delta p = 1$ bar.
 - \downarrow - 125 l/min must be available for the semi automatic condensate drain to close correctly.

Standard nominal flow rate $q_{mN}^{1)}$ [l/min]											
Size	Mini			Midi				Maxi			
Pneumatic connection 1, 2	G $\frac{1}{8}$	G $\frac{1}{4}$	G $\frac{3}{8}$	G $\frac{1}{4}$	G $\frac{3}{8}$	G $\frac{1}{2}$	G $\frac{3}{4}$	G $\frac{1}{2}$	G $\frac{3}{4}$	G1	
Pressure regulation range, grade of filtration	0.5 ... 7 bar, 40 μ m	900	1,500	1,700	2,100	3,200	3,900	4,000	9,500 (7,600) ²⁾	10,000 (7,700) ²⁾	11,000 (7,800) ²⁾
	0.5 ... 12 bar, 5 μ m	650	1,200	1,350	1,600	2,400	2,600	2,600	7,500 (4,000) ²⁾	7,600 (5,800) ²⁾	8,000 (6,000) ²⁾
	0.5 ... 12 bar, 40 μ m	750	1,400	1,600	2,000	3,100	3,400	3,400	9,400 (4,500) ²⁾	9,700 (6,800) ²⁾	10,000 (7,000) ²⁾

- 1) Measured at $p_1 = 10$ bar, $p_2 = 6$ bar and $\Delta p = 1$ bar.
 2) For the LR/LRS-...DI.
 - \downarrow - 125 l/min must be available for the fully automatic condensate drain to close correctly.

Operating and environmental conditions				
Condensate drain	Manual rotary		Semi-automatic	Fully automatic
Size	Micro	Mini/Midi/Maxi	Micro	Mini/Midi/Maxi
Operating pressure [bar]	1 ... 10		1 ... 10	2 ... 12
Operating medium	Compressed air in accordance with ISO 8573-1:2010 [7:9:-]		Compressed air in accordance with ISO 8573-1:2010 [7:9:-]	Compressed air in accordance with ISO 8573-1:2010 [7:9:-]
	Inert gases			
Ambient temperature [°C]	-10 ... +60			+5 ... +60
Temperature of medium [°C]	-10 ... +60			+5 ... +60
Storage temperature [°C]	-10 ... +60			
Corrosion resistance class CRC ¹⁾	2			
Maritime classification	See certificate (only LFR) ²⁾			

- 1) Corrosion resistance class CRC 2 to Festo standard FN 940070
 Moderate corrosion stress. Indoor applications in which condensation may occur. External visible parts with primarily decorative requirements for the surface and which are in direct contact with the ambient atmosphere typical for industrial applications.
 2) Additional information www.festo.com/sp → Certificates.

Weight [g]						
Size	Micro		Mini	Midi	Maxi	
	Connecting thread	Connecting plate			Connection G $\frac{1}{2}$, G $\frac{3}{4}$	Connection G1
With pressure gauge						
LFR-...	104	124	460	920	1,370	1,470
LFR-...-DI	-	-	-	-	1,670	1,670
LFRS-...	-	-	560	1,160	1,470	1,570
LFRS-...-DI	-	-	-	-	1,950	1,950
Without pressure gauge						
LFR-...	94	114	410	830	1,300	1,400
LFR-...-DI	-	-	-	-	1,600	1,600
LFRS-...	-	-	510	1,070	1,400	1,500
LFRS-...-DI	-	-	-	-	1,880	1,880

Filter regulators LFR/LFRS, D series, metal design

Technical data

Materials

Sectional view

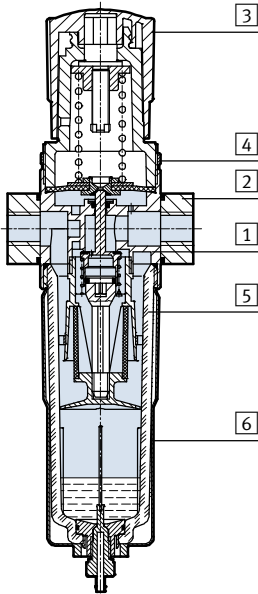

Size	Micro	Mini/Midi/Maxi	
		With pressure gauge	Without pressure gauge
1 Housing	Wrought aluminium alloy	Die-cast zinc	
2 Connecting plates	Wrought aluminium alloy	Die-cast zinc/aluminium	
3 Regulating knob	POM	PA	
4 Knurled nut	-	Aluminium	
5 Bowl	PC	PC	
6 Metal bowl guard	-	Aluminium	
- Seals	NBR	NBR	
Note on materials	RoHS-compliant	RoHS-compliant	Free of copper and PTFE (LFR only)

Standard flow rate qn as a function of the output pressure p2

LFR-M5-...-MICRO

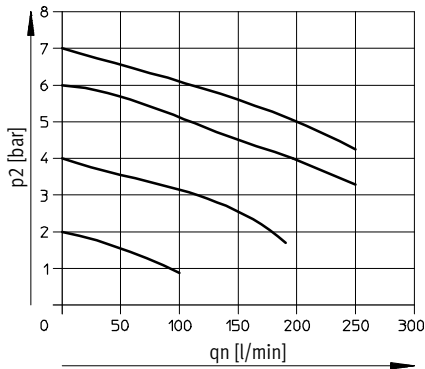

LFR-M7-...-MICRO -B

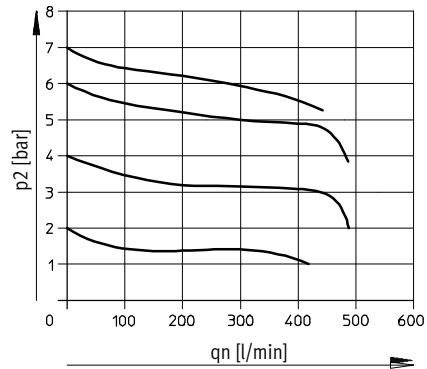

LFR-QS4-...-MICRO

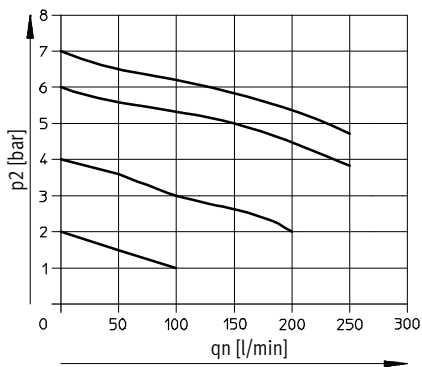

LFR-QS6-...-MICRO and LFR-1/8-...-MICRO

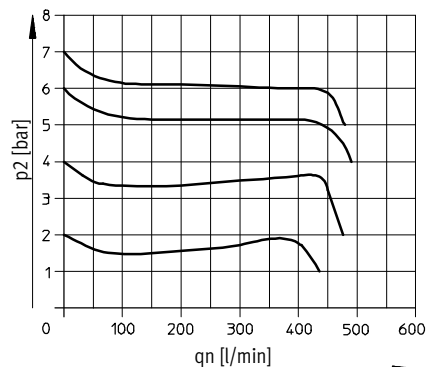

Primary pressure p1 = 10 bar

Filter regulators LFR/LFRS, D series, metal design

Technical data

Standard flow rate q_n as a function of the output pressure p_2

LFR/LFRS-1/4-D-MINI

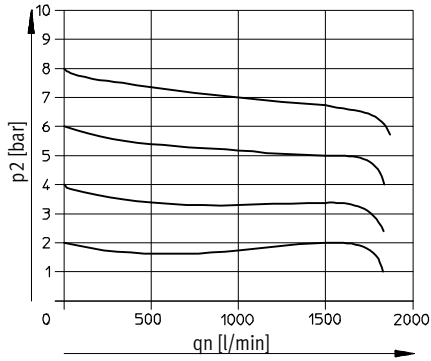

LFR/LFRS-1/2-D-MIDI

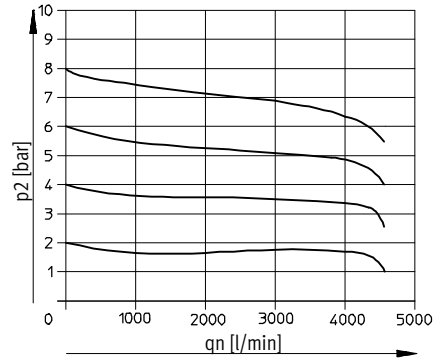

LFR/LFRS-1-D-MAXI

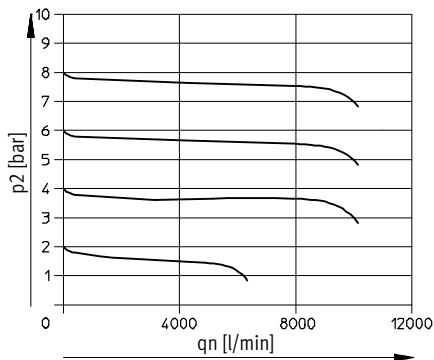

LFR/LFRS-1-D-DI-MAXI

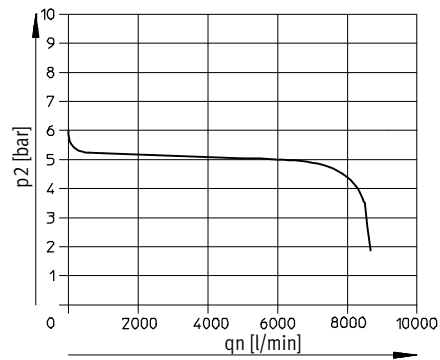

Primary pressure $p_1 = 10$ bar

Note

In order to improve control behaviour, primary-pressure dependent internal air consumption is provided on the LFR/LFRS-...-MAXI.

Internal air consumption q_n as a function of input pressure p_1

LFR/LFRS-...-MAXI

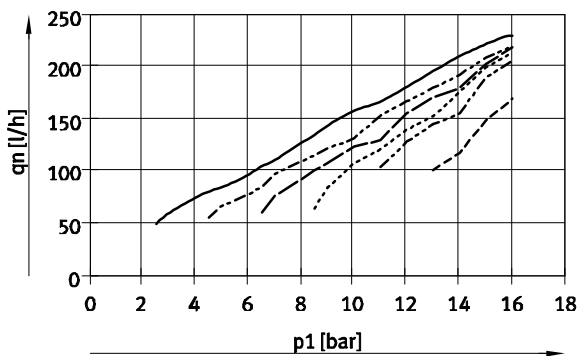

- $p_2 = 2$ bar
- - - $p_2 = 4$ bar
- · - $p_2 = 6$ bar
- · · $p_2 = 8$ bar
- - - $p_2 = 10$ bar
- - - $p_2 = 12$ bar

Filter regulators LFR/LFRS, D series, metal design

Technical data

Dimensions

Download CAD data → www.festo.com

Micro

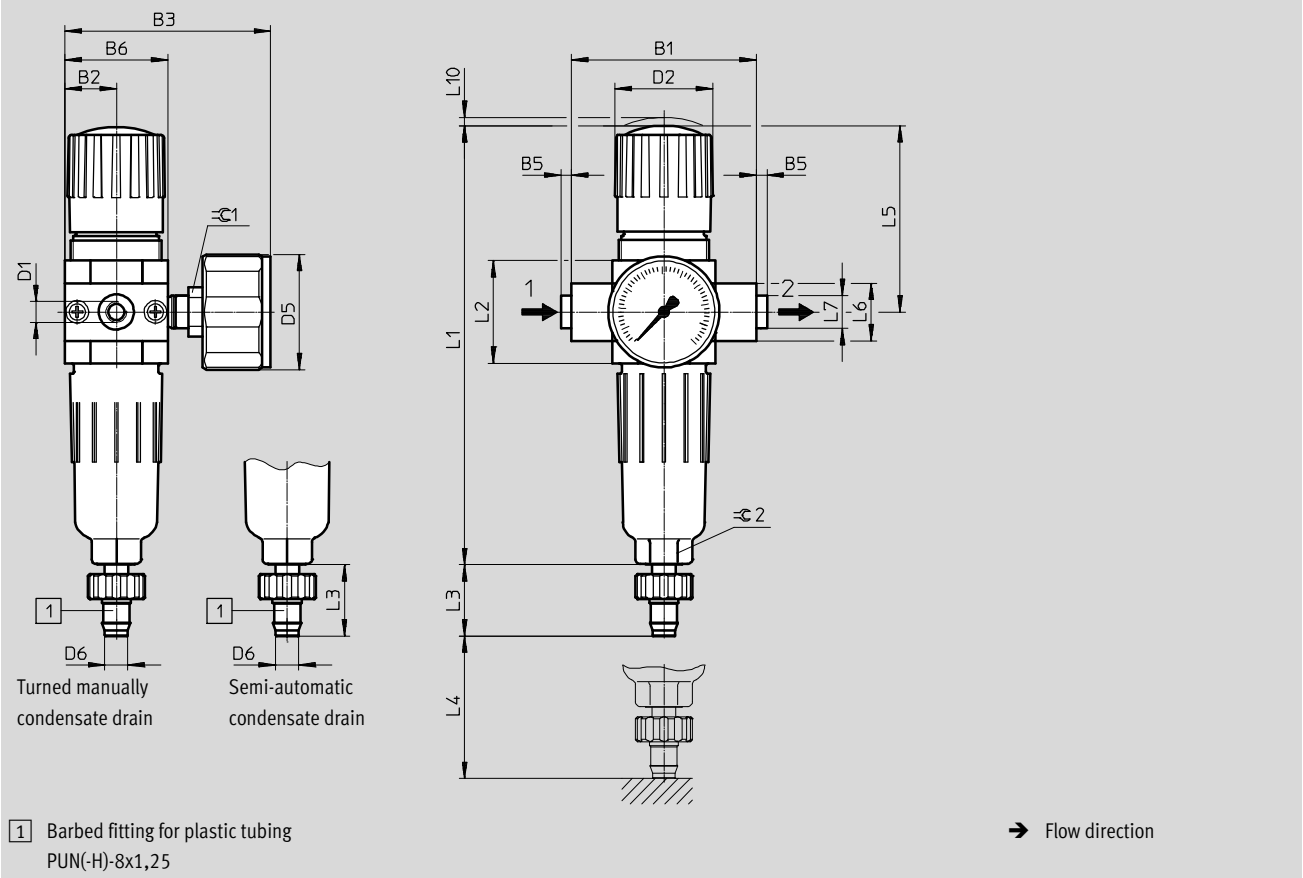

Type	B1	B2	B3	B5	B3	D1	D2 Ø	D5 Ø	D6 Ø
LFR-M5-...-MICRO (H)	25	12.5	50	-	25	M5	~24	28	5.6
LFR-M7-...-MICRO (H) B						M7			
LFR-1/8-...-MICRO (H)	45	12.5	50	~2.5	25	G1/8	~24	28	5.6
LFR-QS4-...-MICRO (H)						QS-4			
LFR-QS6-...-MICRO (H)						QS-6			

Type	L1	L2	L3	L4 min.	L5	L6	L7	L10	≈C 1	≈C 2
LFR-M5-...-MICRO (H)	107.5	26	~17.3	60	46	14	-	2	12	12
LFR-M7-...-MICRO (H) B										
LFR-1/8-...-MICRO (H)										
LFR-QS4-...-MICRO (H)										
LFR-QS6-...-MICRO (H)										

Note: This product conforms to ISO 1179-1 and to ISO 228-1

Filter regulators LFR/LFRS, D series, metal design

Technical data

FESTO

Dimensions

Download CAD data → www.festo.com

Mini/Midi/Maxi

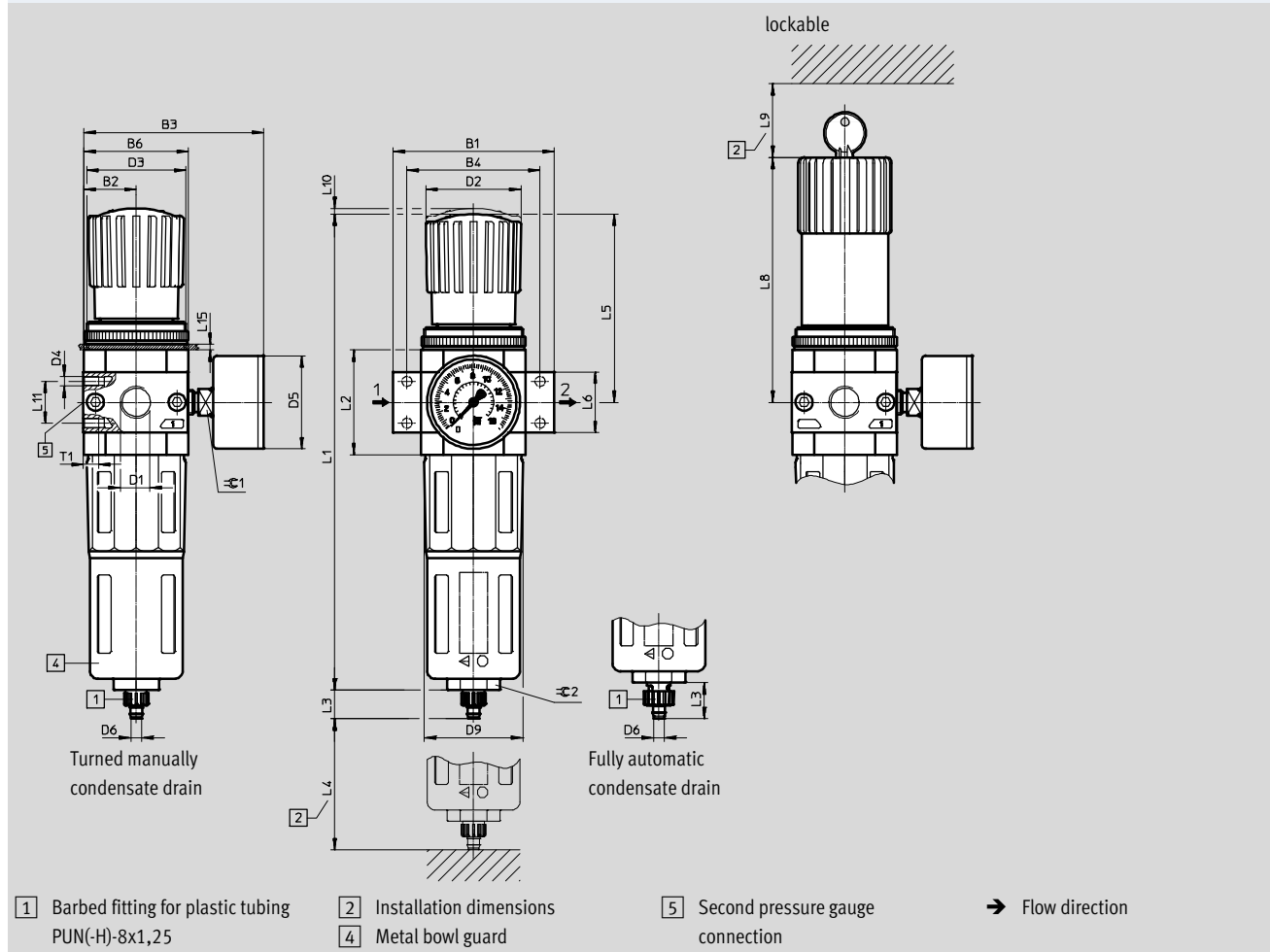

Type	B1	B2	B3	B4	B6	D1	D2	D3	D4	D5	D6	D9
							∅			∅	∅	∅
Mini												
LFR/LFRS-1/8-D-MINI (A)	64	20	76	~52	40	G1/8	31	M36x1.5	M4	41	5.6	38
LFR/LFRS-1/4-D-MINI (A)						G1/4						
LFR/LFRS-3/8-D-MINI (A)	70					G3/8						
Midi												
LFR/LFRS-1/4-D-MIDI (A)	~85	27.5	~94.5	~70	55	G1/4	50	M52x1.5	M5	49	5.6	52
LFR/LFRS-3/8-D-MIDI (A)						G3/8						
LFR/LFRS-1/2-D-MIDI (A)						G1/2						
LFR/LFRS-3/4-D-MIDI (A)						G3/4						
Maxi												
LFR/LFRS-1/2-D-MAXI (A)	96	33	106	80	66	G1/2	31	M36x1.5	M5	49	5.6	65
LFR/LFRS-1/2-D-DI-MAXI (A)			105				49	M52x1.5				
LFR/LFRS-3/4-D-MAXI (A)			106			49	M52x1.5					
LFR/LFRS-3/4-D-DI-MAXI (A)			105									
LFR/LFRS-1-D-MAXI (A)	116		106	91		G1	31	M36x1.5				
LFR/LFRS-1-D-DI-MAXI (A)			105				49	M52x1.5				

|| - Note: This product conforms to ISO 1179-1 and to ISO 228-1

Filter regulators LFR/LFRS, D series, metal design

Technical data

Type	L1	L2	L3	L4 min.	L5	L6	L8	L9	L10	L11 ±0.2	L15 max.	T1 min.	≈C 1	≈C 2
Mini														
LFR/LFRS-1/8-D-MINI (A)	192.9	40	15 (19) ¹⁾	60	~69	20	98	60	3	11	3	7	14	22
LFR/LFRS-1/4-D-MINI (A)														
LFR/LFRS-3/8-D-MINI (A)														
Midi														
LFR/LFRS-1/4-D-MIDI (A)	250	55 ±0.1	15 (19) ¹⁾	80	99	32 ±0.3	130	60	3	22	5	8	14	24
LFR/LFRS-3/8-D-MIDI (A)														
LFR/LFRS-1/2-D-MIDI (A)														
LFR/LFRS-3/4-D-MIDI (A)														
Maxi														
LFR/LFRS-1/2-D-MAXI (A)	252	66	15 (19) ¹⁾	90	82	32	111	60	3	22	4	8	14	24
LFR/LFRS-1/2-D-DI-MAXI (A)	275				~105	32	135		4					
LFR/LFRS-3/4-D-MAXI (A)	252				82	32	111		3					
LFR/LFRS-3/4-D-DI-MAXI (A)	275				~105	36	135		4					
LFR/LFRS-1-D-MAXI (A)	252				82	40	111		3					
LFR/LFRS-1-D-DI-MAXI (A)	275				~105	41	135		4					

1) Value in brackets applies to the fully automatic condensate drain.

Filter regulators LFR/LFRS, D series, metal design

Technical data

Ordering data			
Pressure regulation range 0.5 ... 7 bar			
Condensate drain	Size	Connection	Grade of filtration 5 µm
			Part No. Type
With pressure gauge, outer scale in bar			
Turned manually	Micro	Without connecting plates, connecting thread in housing	
		M5	526273 LFR-M5-D-7-5M-MICRO
		M7	534184 LFR-M7-D-7-5M-MICRO-B
		Connecting plates with connecting thread	
		G ¹ / ₈	526277 LFR- ¹ / ₈ -D-7-5M-MICRO
		Connecting plates with push-in connector	
		QS-4	526289 LFR-QS4-D-7-5M-MICRO
		QS-6	526293 LFR-QS6-D-7-5M-MICRO
Semi-automatic	Micro	Without connecting plates, connecting thread in housing	
		M5	526274 LFR-M5-D-7-5M-MICRO-H
		M7	534185 LFR-M7-D-7-5M-MICRO-H-B
		Connecting plates with connecting thread	
		G ¹ / ₈	526278 LFR- ¹ / ₈ -D-7-5M-MICRO-H
		Connecting plates with push-in connector	
		QS-4	526290 LFR-QS4-D-7-5M-MICRO-H
		QS-6	526294 LFR-QS6-D-7-5M-MICRO-H
Without pressure gauge			
Turned manually	Micro	Without connecting plates, connecting thread in housing	
		M5	526275 LFR-M5-D-7-0-5M-MICRO
		M7	534186 LFR-M7-D-7-0-5M-MICRO-B
		Connecting plates with connecting thread	
		G ¹ / ₈	526279 LFR- ¹ / ₈ -D-7-0-5M-MICRO
		Connecting plates with push-in connector	
		QS-4	526291 LFR-QS4-D-7-0-5M-MICRO
		QS-6	526295 LFR-QS6-D-7-0-5M-MICRO
Semi-automatic	Micro	Without connecting plates, connecting thread in housing	
		M5	526276 LFR-M5-D-7-0-5M-MICRO-H
		M7	534187 LFR-M7-D-7-0-5M-MICRO-H-B
		Connecting plates with connecting thread	
		G ¹ / ₈	526280 LFR- ¹ / ₈ -D-7-0-5M-MICRO-H
		Connecting plates with push-in connector	
		QS-4	526292 LFR-QS4-D-7-0-5M-MICRO-H
		QS-6	526296 LFR-QS6-D-7-0-5M-MICRO-H

Filter regulators LFR/LFRS, D series, metal design

Technical data

Ordering data							
Pressure regulation range 0.5 ... 12 bar, rotary knob with detent, connecting plates with connecting thread							
Condensate drain	Size	Connection	Grade of filtration 5 µm		Grade of filtration 40 µm		
			Part No.	Type	Part No.	Type	
With pressure gauge, outer scale in bar, inner scale in psi							
Turned manually	Mini	G1/8	162718	LFR-1/8-D-5M-MINI	159630	LFR-1/8-D-MINI	
		G1/4	162719	LFR-1/4-D-5M-MINI	159631	LFR-1/4-D-MINI	
		G3/8	162720	LFR-3/8-D-5M-MINI	162682	LFR-3/8-D-MINI	
	Midi	G1/4	186483	LFR-1/4-D-5M-MIDI	186481	LFR-1/4-D-MIDI	
		G3/8	162721	LFR-3/8-D-5M-MIDI	159582	LFR-3/8-D-MIDI	
		G1/2	162722	LFR-1/2-D-5M-MIDI	159584	LFR-1/2-D-MIDI	
		G3/4	162723	LFR-3/4-D-5M-MIDI	162683	LFR-3/4-D-MIDI	
	Maxi	G1/2	186491	LFR-1/2-D-5M-MAXI	186489	LFR-1/2-D-MAXI	
		G3/4	162724	LFR-3/4-D-5M-MAXI	159632	LFR-3/4-D-MAXI	
		G1	162725	LFR-1-D-5M-MAXI	159633	LFR-1-D-MAXI	
	Fully automatic						
	Fully automatic	Mini	G1/8	162726	LFR-1/8-D-5M-MINI-A	159634	LFR-1/8-D-MINI-A
G1/4			162727	LFR-1/4-D-5M-MINI-A	159635	LFR-1/4-D-MINI-A	
G3/8			162728	LFR-3/8-D-5M-MINI-A	162684	LFR-3/8-D-MINI-A	
Midi		G1/4	186486	LFR-1/4-D-5M-MIDI-A	186484	LFR-1/4-D-MIDI-A	
		G3/8	162729	LFR-3/8-D-5M-MIDI-A	159583	LFR-3/8-D-MIDI-A	
		G1/2	162730	LFR-1/2-D-5M-MIDI-A	159585	LFR-1/2-D-MIDI-A	
		G3/4	162731	LFR-3/4-D-5M-MIDI-A	162685	LFR-3/4-D-MIDI-A	
Maxi		G1/2	186494	LFR-1/2-D-5M-MAXI-A	186492	LFR-1/2-D-MAXI-A	
		G3/4	162732	LFR-3/4-D-5M-MAXI-A	159636	LFR-3/4-D-MAXI-A	
		G1	162733	LFR-1-D-5M-MAXI-A	159637	LFR-1-D-MAXI-A	
Without pressure gauge							
Turned manually							
Turned manually	Mini	G1/8	192610	LFR-1/8-D-5M-O-MINI ¹⁾	162686	LFR-1/8-D-O-MINI ¹⁾	
		G1/4	192611	LFR-1/4-D-5M-O-MINI ¹⁾	162687	LFR-1/4-D-O-MINI ¹⁾	
		G3/8	192612	LFR-3/8-D-5M-O-MINI ¹⁾	162688	LFR-3/8-D-O-MINI ¹⁾	
	Midi	G1/4	192613	LFR-1/4-D-5M-O-MIDI ¹⁾	186482	LFR-1/4-D-O-MIDI ¹⁾	
		G3/8	192614	LFR-3/8-D-5M-O-MIDI ¹⁾	162689	LFR-3/8-D-O-MIDI ¹⁾	
		G1/2	192615	LFR-1/2-D-5M-O-MIDI ¹⁾	162690	LFR-1/2-D-O-MIDI ¹⁾	
		G3/4	192616	LFR-3/4-D-5M-O-MIDI ¹⁾	162691	LFR-3/4-D-O-MIDI ¹⁾	
	Maxi	G1/2	192617	LFR-1/2-D-5M-O-MAXI ¹⁾	186490	LFR-1/2-D-O-MAXI ¹⁾	
		G3/4	192618	LFR-3/4-D-5M-O-MAXI ¹⁾	162692	LFR-3/4-D-O-MAXI ¹⁾	
		G1	192619	LFR-1-D-5M-O-MAXI ¹⁾	162693	LFR-1-D-O-MAXI ¹⁾	
	Fully automatic						
	Fully automatic	Mini	G1/8	192620	LFR-1/8-D-5M-O-MINI-A ¹⁾	162694	LFR-1/8-D-O-MINI-A ¹⁾
G1/4			192621	LFR-1/4-D-5M-O-MINI-A ¹⁾	162695	LFR-1/4-D-O-MINI-A ¹⁾	
G3/8			192622	LFR-3/8-D-5M-O-MINI-A ¹⁾	162696	LFR-3/8-D-O-MINI-A ¹⁾	
Midi		G1/4	192623	LFR-1/4-D-5M-O-MIDI-A ¹⁾	186485	LFR-1/4-D-O-MIDI-A ¹⁾	
		G3/8	192624	LFR-3/8-D-5M-O-MIDI-A ¹⁾	162697	LFR-3/8-D-O-MIDI-A ¹⁾	
		G1/2	192625	LFR-1/2-D-5M-O-MIDI-A ¹⁾	162698	LFR-1/2-D-O-MIDI-A ¹⁾	
		G3/4	192626	LFR-3/4-D-5M-O-MIDI-A ¹⁾	162699	LFR-3/4-D-O-MIDI-A ¹⁾	
Maxi		G1/2	192627	LFR-1/2-D-5M-O-MAXI-A ¹⁾	186493	LFR-1/2-D-O-MAXI-A ¹⁾	
		G3/4	192628	LFR-3/4-D-5M-O-MAXI-A ¹⁾	162700	LFR-3/4-D-O-MAXI-A ¹⁾	
		G1	192629	LFR-1-D-5M-O-MAXI-A ¹⁾	162701	LFR-1-D-O-MAXI-A ¹⁾	

1) Free of copper and PTFE

Filter regulators LFR/LFRS, D series, metal design

FESTO

Technical data

Ordering data				
Pressure regulation range 0.5 ... 7 bar, rotary knob with detent, connecting plates with connecting thread				
Condensate drain	Size	Connection	Grade of filtration 40 µm	
			Part No.	Type
With pressure gauge, outer scale in bar, inner scale in psi				
Turned manually	Mini	G $\frac{1}{8}$	162702	LFR- $\frac{1}{8}$ -D-7-MINI
		G $\frac{1}{4}$	162703	LFR- $\frac{1}{4}$ -D-7-MINI
		G $\frac{3}{8}$	162704	LFR- $\frac{3}{8}$ -D-7-MINI
	Midi	G $\frac{1}{4}$	186487	LFR- $\frac{1}{4}$ -D-7-MIDI
		G $\frac{3}{8}$	162705	LFR- $\frac{3}{8}$ -D-7-MIDI
		G $\frac{1}{2}$	162706	LFR- $\frac{1}{2}$ -D-7-MIDI
		G $\frac{3}{4}$	162707	LFR- $\frac{3}{4}$ -D-7-MIDI
	Maxi	G $\frac{1}{2}$	186495	LFR- $\frac{1}{2}$ -D-7-MAXI
		G $\frac{3}{4}$	162708	LFR- $\frac{3}{4}$ -D-7-MAXI
G1		162709	LFR-1-D-7-MAXI	
Fully automatic				
Fully automatic	Mini	G $\frac{1}{8}$	162710	LFR- $\frac{1}{8}$ -D-7-MINI-A
		G $\frac{1}{4}$	162711	LFR- $\frac{1}{4}$ -D-7-MINI-A
		G $\frac{3}{8}$	162712	LFR- $\frac{3}{8}$ -D-7-MINI-A
	Midi	G $\frac{1}{4}$	186488	LFR- $\frac{1}{4}$ -D-7-MIDI-A
		G $\frac{3}{8}$	162713	LFR- $\frac{3}{8}$ -D-7-MIDI-A
		G $\frac{1}{2}$	162714	LFR- $\frac{1}{2}$ -D-7-MIDI-A
		G $\frac{3}{4}$	162715	LFR- $\frac{3}{4}$ -D-7-MIDI-A
	Maxi	G $\frac{1}{2}$	186496	LFR- $\frac{1}{2}$ -D-7-MAXI-A
		G $\frac{3}{4}$	162716	LFR- $\frac{3}{4}$ -D-7-MAXI-A
G1		162717	LFR-1-D-7-MAXI-A	
Without pressure gauge				
Turned manually	Mini	G $\frac{1}{8}$	192590	LFR- $\frac{1}{8}$ -D-7-O-MINI ¹⁾
		G $\frac{1}{4}$	192591	LFR- $\frac{1}{4}$ -D-7-O-MINI ¹⁾
		G $\frac{3}{8}$	192592	LFR- $\frac{3}{8}$ -D-7-O-MINI ¹⁾
	Midi	G $\frac{1}{4}$	192593	LFR- $\frac{1}{4}$ -D-7-O-MIDI ¹⁾
		G $\frac{3}{8}$	192594	LFR- $\frac{3}{8}$ -D-7-O-MIDI ¹⁾
		G $\frac{1}{2}$	192595	LFR- $\frac{1}{2}$ -D-7-O-MIDI ¹⁾
		G $\frac{3}{4}$	192596	LFR- $\frac{3}{4}$ -D-7-O-MIDI ¹⁾
	Maxi	G $\frac{1}{2}$	192597	LFR- $\frac{1}{2}$ -D-7-O-MAXI ¹⁾
		G $\frac{3}{4}$	192598	LFR- $\frac{3}{4}$ -D-7-O-MAXI ¹⁾
G1		192599	LFR-1-D-7-O-MAXI ¹⁾	
Fully automatic				
Fully automatic	Mini	G $\frac{1}{8}$	192600	LFR- $\frac{1}{8}$ -D-7-O-MINI-A ¹⁾
		G $\frac{1}{4}$	192601	LFR- $\frac{1}{4}$ -D-7-O-MINI-A ¹⁾
		G $\frac{3}{8}$	192602	LFR- $\frac{3}{8}$ -D-7-O-MINI-A ¹⁾
	Midi	G $\frac{1}{4}$	192603	LFR- $\frac{1}{4}$ -D-7-O-MIDI-A ¹⁾
		G $\frac{3}{8}$	192604	LFR- $\frac{3}{8}$ -D-7-O-MIDI-A ¹⁾
		G $\frac{1}{2}$	192605	LFR- $\frac{1}{2}$ -D-7-O-MIDI-A ¹⁾
		G $\frac{3}{4}$	192606	LFR- $\frac{3}{4}$ -D-7-O-MIDI-A ¹⁾
	Maxi	G $\frac{1}{2}$	192607	LFR- $\frac{1}{2}$ -D-7-O-MAXI-A ¹⁾
		G $\frac{3}{4}$	192608	LFR- $\frac{3}{4}$ -D-7-O-MAXI-A ¹⁾
G1		192609	LFR-1-D-7-O-MAXI-A ¹⁾	

1) Free of copper and PTFE

Filter regulators LFR/LFRS, D series, metal design

Technical data

Ordering data						
Pressure regulation range 0.5 ... 12 bar, directly actuated diaphragm regulator with integrated return flow function, rotary knob with detent, connecting plates with connecting thread						
Condensate drain	Size	Connection	Grade of filtration 5 µm		Grade of filtration 40 µm	
			Part No.	Type	Part No.	Type
With pressure gauge, outer scale in bar, inner scale in psi						
Turned manually	Maxi	G1/2	192370	LFR-1/2-D-5M-DI-MAXI	192368	LFR-1/2-D-DI-MAXI
		G3/4	192376	LFR-3/4-D-5M-DI-MAXI	192374	LFR-3/4-D-DI-MAXI
		G1	192382	LFR-1-D-5M-DI-MAXI	192380	LFR-1-D-DI-MAXI
Fully automatic	Maxi	G1/2	192388	LFR-1/2-D-5M-DI-MAXI-A	192386	LFR-1/2-D-DI-MAXI-A
		G3/4	192394	LFR-3/4-D-5M-DI-MAXI-A	192392	LFR-3/4-D-DI-MAXI-A
		G1	192400	LFR-1-D-5M-DI-MAXI-A	192398	LFR-1-D-DI-MAXI-A
Without pressure gauge						
Turned manually	Maxi	G1/2	192371	LFR-1/2-D-5M-O-DI-MAXI	192369	LFR-1/2-D-O-DI-MAXI
		G3/4	192377	LFR-3/4-D-5M-O-DI-MAXI	192375	LFR-3/4-D-O-DI-MAXI
		G1	192383	LFR-1-D-5M-O-DI-MAXI	192381	LFR-1-D-O-DI-MAXI
Fully automatic	Maxi	G1/2	192389	LFR-1/2-D-5M-O-DI-MAXI-A	192387	LFR-1/2-D-O-DI-MAXI-A
		G3/4	192395	LFR-3/4-D-5M-O-DI-MAXI-A	192393	LFR-3/4-D-O-DI-MAXI-A
		G1	192401	LFR-1-D-5M-O-DI-MAXI-A	192399	LFR-1-D-O-DI-MAXI-A

Ordering data						
Pressure regulation range 0.5 ... 7 bar, directly actuated diaphragm regulator with integrated return flow function, rotary knob with detent, connecting plates with connecting thread						
Condensate drain	Size	Connection	Grade of filtration 5 µm		Grade of filtration 40 µm	
			Part No.	Type	Part No.	Type
With pressure gauge, outer scale in bar, inner scale in psi						
Turned manually	Maxi	G1/2	-	-	192372	LFR-1/2-D-7-DI-MAXI
		G3/4	-	-	192378	LFR-3/4-D-7-DI-MAXI
		G1	-	-	192384	LFR-1-D-7-DI-MAXI
Fully automatic	Maxi	G1/2	-	-	192390	LFR-1/2-D-7-DI-MAXI-A
		G3/4	-	-	192396	LFR-3/4-D-7-DI-MAXI-A
		G1	-	-	192402	LFR-1-D-7-DI-MAXI-A
Without pressure gauge						
Turned manually	Maxi	G1/2	-	-	192373	LFR-1/2-D-7-O-DI-MAXI
		G3/4	-	-	192379	LFR-3/4-D-7-O-DI-MAXI
		G1	-	-	192385	LFR-1-D-7-O-DI-MAXI
Fully automatic	Maxi	G1/2	-	-	192391	LFR-1/2-D-7-O-DI-MAXI-A
		G3/4	-	-	192397	LFR-3/4-D-7-O-DI-MAXI-A
		G1	-	-	192403	LFR-1-D-7-O-DI-MAXI-A

Filter regulators LFR/LFRS, D series, metal design

FESTO

Technical data

Ordering data							
Pressure regulation range 0.5 ... 12 bar, rotary knob with integrated lock, connecting plates with connecting thread							
Condensate drain	Size	Connection	Grade of filtration 5 µm		Grade of filtration 40 µm		
			Part No.	Type	Part No.	Type	
With pressure gauge, outer scale in bar, inner scale in psi							
Turned manually	Mini	G $\frac{1}{8}$	194704	LFRS- $\frac{1}{8}$ -D-5M-MINI	194696	LFRS- $\frac{1}{8}$ -D-MINI	
		G $\frac{1}{4}$	194716	LFRS- $\frac{1}{4}$ -D-5M-MINI	194708	LFRS- $\frac{1}{4}$ -D-MINI	
		G $\frac{3}{8}$	194728	LFRS- $\frac{3}{8}$ -D-5M-MINI	194720	LFRS- $\frac{3}{8}$ -D-MINI	
	Midi	G $\frac{1}{4}$	194740	LFRS- $\frac{1}{4}$ -D-5M-MIDI	194732	LFRS- $\frac{1}{4}$ -D-MIDI	
		G $\frac{3}{8}$	194752	LFRS- $\frac{3}{8}$ -D-5M-MIDI	194744	LFRS- $\frac{3}{8}$ -D-MIDI	
		G $\frac{1}{2}$	194764	LFRS- $\frac{1}{2}$ -D-5M-MIDI	194756	LFRS- $\frac{1}{2}$ -D-MIDI	
		G $\frac{3}{4}$	194776	LFRS- $\frac{3}{4}$ -D-5M-MIDI	194768	LFRS- $\frac{3}{4}$ -D-MIDI	
	Maxi	G $\frac{1}{2}$	194788	LFRS- $\frac{1}{2}$ -D-5M-MAXI	194780	LFRS- $\frac{1}{2}$ -D-MAXI	
		G $\frac{3}{4}$	194800	LFRS- $\frac{3}{4}$ -D-5M-MAXI	194792	LFRS- $\frac{3}{4}$ -D-MAXI	
		G1	194812	LFRS-1-D-5M-MAXI	194804	LFRS-1-D-MAXI	
	Fully automatic						
	Fully automatic	Mini	G $\frac{1}{8}$	194706	LFRS- $\frac{1}{8}$ -D-5M-MINI-A	194697	LFRS- $\frac{1}{8}$ -D-MINI-A
G $\frac{1}{4}$			194718	LFRS- $\frac{1}{4}$ -D-5M-MINI-A	194709	LFRS- $\frac{1}{4}$ -D-MINI-A	
G $\frac{3}{8}$			194730	LFRS- $\frac{3}{8}$ -D-5M-MINI-A	194721	LFRS- $\frac{3}{8}$ -D-MINI-A	
Midi		G $\frac{1}{4}$	194742	LFRS- $\frac{1}{4}$ -D-5M-MIDI-A	194733	LFRS- $\frac{1}{4}$ -D-MIDI-A	
		G $\frac{3}{8}$	194754	LFRS- $\frac{3}{8}$ -D-5M-MIDI-A	194745	LFRS- $\frac{3}{8}$ -D-MIDI-A	
		G $\frac{1}{2}$	194766	LFRS- $\frac{1}{2}$ -D-5M-MIDI-A	194757	LFRS- $\frac{1}{2}$ -D-MIDI-A	
		G $\frac{3}{4}$	194778	LFRS- $\frac{3}{4}$ -D-5M-MIDI-A	194769	LFRS- $\frac{3}{4}$ -D-MIDI-A	
Maxi		G $\frac{1}{2}$	194790	LFRS- $\frac{1}{2}$ -D-5M-MAXI-A	194781	LFRS- $\frac{1}{2}$ -D-MAXI-A	
		G $\frac{3}{4}$	194802	LFRS- $\frac{3}{4}$ -D-5M-MAXI-A	194793	LFRS- $\frac{3}{4}$ -D-MAXI-A	
		G1	194814	LFRS-1-D-5M-MAXI-A	194805	LFRS-1-D-MAXI-A	
Without pressure gauge							
Turned manually		Mini	G $\frac{1}{8}$	194705	LFRS- $\frac{1}{8}$ -D-5M-O-MINI	194698	LFRS- $\frac{1}{8}$ -D-O-MINI
	G $\frac{1}{4}$		194717	LFRS- $\frac{1}{4}$ -D-5M-O-MINI	194710	LFRS- $\frac{1}{4}$ -D-O-MINI	
	G $\frac{3}{8}$		194729	LFRS- $\frac{3}{8}$ -D-5M-O-MINI	194722	LFRS- $\frac{3}{8}$ -D-O-MINI	
	Midi	G $\frac{1}{4}$	194741	LFRS- $\frac{1}{4}$ -D-5M-O-MIDI	194734	LFRS- $\frac{1}{4}$ -D-O-MIDI	
		G $\frac{3}{8}$	194753	LFRS- $\frac{3}{8}$ -D-5M-O-MIDI	194746	LFRS- $\frac{3}{8}$ -D-O-MIDI	
		G $\frac{1}{2}$	194765	LFRS- $\frac{1}{2}$ -D-5M-O-MIDI	194758	LFRS- $\frac{1}{2}$ -D-O-MIDI	
		G $\frac{3}{4}$	194777	LFRS- $\frac{3}{4}$ -D-5M-O-MIDI	194770	LFRS- $\frac{3}{4}$ -D-O-MIDI	
	Maxi	G $\frac{1}{2}$	194789	LFRS- $\frac{1}{2}$ -D-5M-O-MAXI	194782	LFRS- $\frac{1}{2}$ -D-O-MAXI	
		G $\frac{3}{4}$	194801	LFRS- $\frac{3}{4}$ -D-5M-O-MAXI	194794	LFRS- $\frac{3}{4}$ -D-O-MAXI	
		G1	194813	LFRS-1-D-5M-O-MAXI	194806	LFRS-1-D-O-MAXI	
	Fully automatic						
	Fully automatic	Mini	G $\frac{1}{8}$	194707	LFRS- $\frac{1}{8}$ -D-5M-O-MINI-A	194699	LFRS- $\frac{1}{8}$ -D-O-MINI-A
G $\frac{1}{4}$			194719	LFRS- $\frac{1}{4}$ -D-5M-O-MINI-A	194711	LFRS- $\frac{1}{4}$ -D-O-MINI-A	
G $\frac{3}{8}$			194731	LFRS- $\frac{3}{8}$ -D-5M-O-MINI-A	194723	LFRS- $\frac{3}{8}$ -D-O-MINI-A	
Midi		G $\frac{1}{4}$	194743	LFRS- $\frac{1}{4}$ -D-5M-O-MIDI-A	194735	LFRS- $\frac{1}{4}$ -D-O-MIDI-A	
		G $\frac{3}{8}$	194755	LFRS- $\frac{3}{8}$ -D-5M-O-MIDI-A	194747	LFRS- $\frac{3}{8}$ -D-O-MIDI-A	
		G $\frac{1}{2}$	194767	LFRS- $\frac{1}{2}$ -D-5M-O-MIDI-A	194759	LFRS- $\frac{1}{2}$ -D-O-MIDI-A	
		G $\frac{3}{4}$	194779	LFRS- $\frac{3}{4}$ -D-5M-O-MIDI-A	194771	LFRS- $\frac{3}{4}$ -D-O-MIDI-A	
Maxi		G $\frac{1}{2}$	194791	LFRS- $\frac{1}{2}$ -D-5M-O-MAXI-A	194783	LFRS- $\frac{1}{2}$ -D-O-MAXI-A	
		G $\frac{3}{4}$	194803	LFRS- $\frac{3}{4}$ -D-5M-O-MAXI-A	194795	LFRS- $\frac{3}{4}$ -D-O-MAXI-A	
		G1	194815	LFRS-1-D-5M-O-MAXI-A	194807	LFRS-1-D-O-MAXI-A	

Filter regulators LFR/LFRS, D series, metal design

Technical data

Ordering data				
Pressure regulation range 0.5 ... 7 bar, rotary knob with integrated lock, connecting plates with connecting thread				
Condensate drain	Size	Connection	Grade of filtration 40 µm	
			Part No.	Type
With pressure gauge, outer scale in bar, inner scale in psi				
Turned manually	Mini	G $\frac{1}{8}$	194700	LFRS- $\frac{1}{8}$ -D-7-MINI
		G $\frac{1}{4}$	194712	LFRS- $\frac{1}{4}$ -D-7-MINI
		G $\frac{3}{8}$	194724	LFRS- $\frac{3}{8}$ -D-7-MINI
	Midi	G $\frac{1}{4}$	194736	LFRS- $\frac{1}{4}$ -D-7-MIDI
		G $\frac{3}{8}$	194748	LFRS- $\frac{3}{8}$ -D-7-MIDI
		G $\frac{1}{2}$	194760	LFRS- $\frac{1}{2}$ -D-7-MIDI
		G $\frac{3}{4}$	194772	LFRS- $\frac{3}{4}$ -D-7-MIDI
	Maxi	G $\frac{1}{2}$	194784	LFRS- $\frac{1}{2}$ -D-7-MAXI
		G $\frac{3}{4}$	194796	LFRS- $\frac{3}{4}$ -D-7-MAXI
G1	194808	LFRS-1-D-7-MAXI		
Fully automatic				
Fully automatic	Mini	G $\frac{1}{8}$	194702	LFRS- $\frac{1}{8}$ -D-7-MINI-A
		G $\frac{1}{4}$	194714	LFRS- $\frac{1}{4}$ -D-7-MINI-A
		G $\frac{3}{8}$	194726	LFRS- $\frac{3}{8}$ -D-7-MINI-A
	Midi	G $\frac{1}{4}$	194738	LFRS- $\frac{1}{4}$ -D-7-MIDI-A
		G $\frac{3}{8}$	194750	LFRS- $\frac{3}{8}$ -D-7-MIDI-A
		G $\frac{1}{2}$	194762	LFRS- $\frac{1}{2}$ -D-7-MIDI-A
		G $\frac{3}{4}$	194774	LFRS- $\frac{3}{4}$ -D-7-MIDI-A
	Maxi	G $\frac{1}{2}$	194786	LFRS- $\frac{1}{2}$ -D-7-MAXI-A
		G $\frac{3}{4}$	194798	LFRS- $\frac{3}{4}$ -D-7-MAXI-A
G1	194810	LFRS-1-D-7-MAXI-A		
Without pressure gauge				
Turned manually	Mini	G $\frac{1}{8}$	194701	LFRS- $\frac{1}{8}$ -D-7-O-MINI
		G $\frac{1}{4}$	194713	LFRS- $\frac{1}{4}$ -D-7-O-MINI
		G $\frac{3}{8}$	194725	LFRS- $\frac{3}{8}$ -D-7-O-MINI
	Midi	G $\frac{1}{4}$	194737	LFRS- $\frac{1}{4}$ -D-7-O-MIDI
		G $\frac{3}{8}$	194749	LFRS- $\frac{3}{8}$ -D-7-O-MIDI
		G $\frac{1}{2}$	194761	LFRS- $\frac{1}{2}$ -D-7-O-MIDI
		G $\frac{3}{4}$	194773	LFRS- $\frac{3}{4}$ -D-7-O-MIDI
	Maxi	G $\frac{1}{2}$	194785	LFRS- $\frac{1}{2}$ -D-7-O-MAXI
		G $\frac{3}{4}$	194797	LFRS- $\frac{3}{4}$ -D-7-O-MAXI
G1	194809	LFRS-1-D-7-O-MAXI		
Fully automatic				
Fully automatic	Mini	G $\frac{1}{8}$	194703	LFRS- $\frac{1}{8}$ -D-7-O-MINI-A
		G $\frac{1}{4}$	194715	LFRS- $\frac{1}{4}$ -D-7-O-MINI-A
		G $\frac{3}{8}$	194727	LFRS- $\frac{3}{8}$ -D-7-O-MINI-A
	Midi	G $\frac{1}{4}$	194739	LFRS- $\frac{1}{4}$ -D-7-O-MIDI-A
		G $\frac{3}{8}$	194751	LFRS- $\frac{3}{8}$ -D-7-O-MIDI-A
		G $\frac{1}{2}$	194763	LFRS- $\frac{1}{2}$ -D-7-O-MIDI-A
		G $\frac{3}{4}$	194775	LFRS- $\frac{3}{4}$ -D-7-O-MIDI-A
	Maxi	G $\frac{1}{2}$	194787	LFRS- $\frac{1}{2}$ -D-7-O-MAXI-A
		G $\frac{3}{4}$	194799	LFRS- $\frac{3}{4}$ -D-7-O-MAXI-A
G1	194811	LFRS-1-D-7-O-MAXI-A		

Filter regulators LFR/LFRS, D series, metal design

Technical data

Ordering data						
Pressure regulation range 0.5 ... 12 bar, directly actuated diaphragm regulator with integrated return flow function, rotary knob with integrated lock, connecting plates with connecting thread						
Condensate drain	Size	Connection	Grade of filtration 5 µm		Grade of filtration 40 µm	
			Part No.	Type	Part No.	Type
With pressure gauge, outer scale in bar, inner scale in psi						
Turned manually	Maxi	G1/2	194818	LFRS-1/2-D-5M-DI-MAXI	194816	LFRS-1/2-D-DI-MAXI
		G3/4	194824	LFRS-3/4-D-5M-DI-MAXI	194822	LFRS-3/4-D-DI-MAXI
		G1	194830	LFRS-1-D-5M-DI-MAXI	194828	LFRS-1-D-DI-MAXI
Fully automatic	Maxi	G1/2	194836	LFRS-1/2-D-5M-DI-MAXI-A	194834	LFRS-1/2-D-DI-MAXI-A
		G3/4	194842	LFRS-3/4-D-5M-DI-MAXI-A	194840	LFRS-3/4-D-DI-MAXI-A
		G1	194848	LFRS-1-D-5M-DI-MAXI-A	194846	LFRS-1-D-DI-MAXI-A
Without pressure gauge						
Turned manually	Maxi	G1/2	194819	LFRS-1/2-D-5M-O-DI-MAXI	194817	LFRS-1/2-D-O-DI-MAXI
		G3/4	194825	LFRS-3/4-D-5M-O-DI-MAXI	194823	LFRS-3/4-D-O-DI-MAXI
		G1	194831	LFRS-1-D-5M-O-DI-MAXI	194829	LFRS-1-D-O-DI-MAXI
Fully automatic	Maxi	G1/2	194837	LFRS-1/2-D-5M-O-DI-MAXI-A	194835	LFRS-1/2-D-O-DI-MAXI-A
		G3/4	194843	LFRS-3/4-D-5M-O-DI-MAXI-A	194841	LFRS-3/4-D-O-DI-MAXI-A
		G1	194849	LFRS-1-D-5M-O-DI-MAXI-A	194847	LFRS-1-D-O-DI-MAXI-A

Ordering data						
Pressure regulation range 0.5 ... 7 bar, directly actuated diaphragm regulator with integrated return flow function, rotary knob with integrated lock, connecting plates with connecting thread						
Condensate drain	Size	Connection	Grade of filtration 5 µm		Grade of filtration 40 µm	
			Part No.	Type	Part No.	Type
With pressure gauge, outer scale in bar, inner scale in psi						
Turned manually	Maxi	G1/2	-	-	194820	LFRS-1/2-D-7-DI-MAXI
		G3/4	-	-	194826	LFRS-3/4-D-7-DI-MAXI
		G1	-	-	194832	LFRS-1-D-7-DI-MAXI
Fully automatic	Maxi	G1/2	-	-	194838	LFRS-1/2-D-7-DI-MAXI-A
		G3/4	-	-	194844	LFRS-3/4-D-7-DI-MAXI-A
		G1	-	-	194850	LFRS-1-D-7-DI-MAXI-A
Without pressure gauge						
Turned manually	Maxi	G1/2	-	-	194821	LFRS-1/2-D-7-O-DI-MAXI
		G3/4	-	-	194827	LFRS-3/4-D-7-O-DI-MAXI
		G1	-	-	194833	LFRS-1-D-7-O-DI-MAXI
Fully automatic	Maxi	G1/2	-	-	194839	LFRS-1/2-D-7-O-DI-MAXI-A
		G3/4	-	-	194845	LFRS-3/4-D-7-O-DI-MAXI-A
		G1	-	-	194851	LFRS-1-D-7-O-DI-MAXI-A



Filter regulators LFR/LFRS, D series, metal design

Technical data

FESTO

Filter regulators LFR, D series, polymer

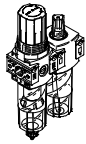
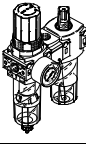
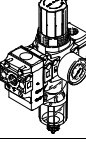
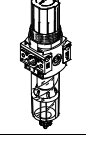
Product range overview D series service units, polymer

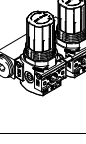
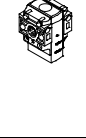
Type	Size	Pneumatic connection		Pressure regulation range [bar]	Grade of filtration [µm]		
		G¼	G½		5	40	
Service units							
FRC		Mini	■	-	■	■	■
Service unit combinations							
FRC-K		Mini	■	-	■	-	■
LFR-K		Mini	■	-	■	-	■
Individual devices							
Filter regulators LFR		Mini	■	-	■	■	■
Pressure regulators LR		Mini	■	-	■	-	-
Pressure regulator combinations LRB-K		Mini	-	■	■	-	-
On-off valves HE		Mini	■	-	-	-	-

Filter regulators LFR, D series, polymer

Product range overview D series service units, polymer



Type	Size	Condensate drain		Pressure display		Actuator lock	Regulating functions		→ Page/ Internet
		Manual rotary	Semi-automatic	With pressure gauge	Without pressure gauge		With secondary venting	With return flow function	
Service units									
FRC	Mini	■	■	■	-	■	■	■	frc
Service unit combinations									
FRC-K	Mini	■	-	■	-	■	■	■	frc
LFR-K	Mini	■	-	■	-	■	■	■	lfr
Individual devices									
Filter regulators LFR	Mini	■	■	■	■	■	■	■	26
Pressure regulators LR	Mini	-	-	■	■	■	■	■	lr
Pressure regulator combinations LRB-K	Mini	-	-	-	■	■	■	■	lrb
On-off valves HE	Mini	-	-	-	■	-	-	-	he

Filter regulators LFR, D series, polymer

Peripherals overview

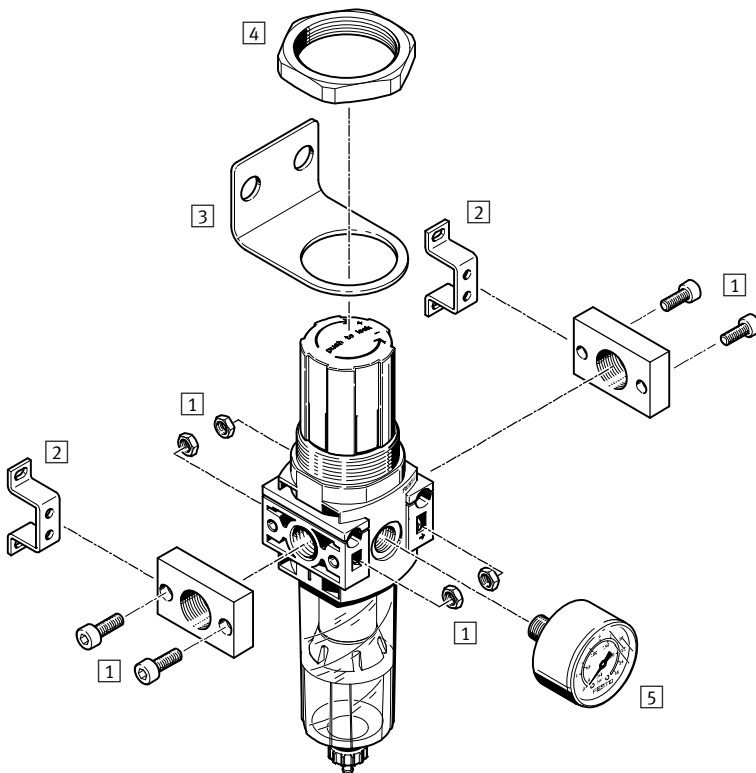

Mounting attachments and accessories		→ Page/ Internet
1	Connecting plate kit PBL	pbl
2	Mounting bracket HFOE	hfoe-d
3	Mounting bracket HR-D	hr-d
4	Hex nut HMR	hmr-d
5	Pressure gauge MA	32

Filter regulators LFR, D series, polymer

Type codes

LFR - 1/4 - DB - 7 - 5M - 0 - MINI - H

Basic function

LFR	Filter regulator
-----	------------------

Pneumatic connection

1/4	Thread G1/4
-----	-------------

Series

DB	Series
----	--------

Pressure regulation range

7	0.5 ... 7 bar
---	---------------

Grade of filtration

	40 µm
5M	5 µm

Pressure gauge

	With pressure gauge
0	Without pressure gauge

Size

MINI	
------	--

Condensate drain

	Manual rotary
H	Semi-automatic

Filter regulators LFR, D series, polymer

Technical data

FESTO

Manual rotary condensate drain,
with pressure gauge

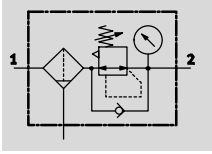

Manual rotary condensate drain,
without pressure gauge

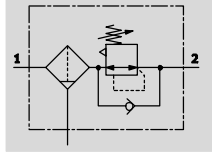

Semi-automatic condensate drain,
with pressure gauge

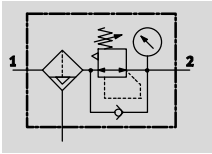

Semi-automatic condensate drain,
without pressure gauge

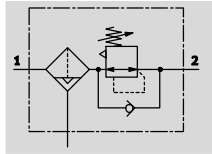

- Flow rate
500 ... 1,200 l/min
- Temperature range
-5 ... +50 °C
- Operating pressure
1.5 ... 10 bar

- Space-saving design with filter and regulator in a single unit
- Good particle separation and high flow rate

- Good regulating characteristics with minimal hysteresis
- With manual or semi-automatic condensate drain

- Setting values are secured by locking the rotary knob
- Choice of filter cartridges: 5 µm or 40 µm
- New filter cartridges → 31

General technical data		
Size	Mini	
	with pressure gauge	without pressure gauge
Pneumatic connection 1, 2	G $\frac{3}{4}$	
Design	Filter regulator with pressure gauge	Filter regulator without pressure gauge
Regulating function	With return flow function, with secondary venting	
Type of mounting	Inline installation	
	Via through-holes	
	Via mounting bracket	
Assembly position	Vertical $\pm 5^\circ$	
Grade of filtration [µm]	5	
	40	
Air purity class at the output	Compressed air according to ISO 8573-1:2010 [6:8:4] (grade of filtration 5 µm)	
	Compressed air according to ISO 8573-1:2010 [7:8:4] (grade of filtration 40 µm)	
	Inert gases	
Condensate drain	Manual rotary	
	Semi-automatic	
Regulator lock	Rotary knob with detent	
Pressure regulation range [bar]	0.5 ... 7	
Max. hysteresis [bar]	0.5	
Pressure indication	Via pressure gauge	G $\frac{1}{8}$ prepared
Pressure gauge connection	G $\frac{1}{8}$	

Standard nominal flow rate ¹⁾ qnN [l/min]		
Size	Mini	
	Grade of filtration	5 µm
40 µm		≥ 1,200

1) Measured at p₁ = 10 bar, p₂ = 6 bar and Δp = 1 bar.

- - 125 l/min must be available for the semi automatic condensate drain to close correctly.

Filter regulators LFR, D series, polymer

Technical data

Operating and environmental conditions	
Size	Mini
Operating pressure [bar]	1.5 ... 10
Operating medium	Compressed air in accordance with ISO 8573-1:2010 [-:9:-] Inert gases
Ambient temperature [°C]	-5 ... +50
Temperature of medium [°C]	-5 ... +50
Corrosion resistance class CRC ¹⁾	1

1) Corrosion resistance class CRC 1 to Festo standard FN 940070
Low corrosion stress. For dry indoor applications or transport and storage protection. Also applies to parts behind covers, in the non-visible interior area, and parts which are covered in the application (e.g. drive trunnions).

Weight [g]	
Size	Mini
Filter regulator	200

Materials

Sectional view

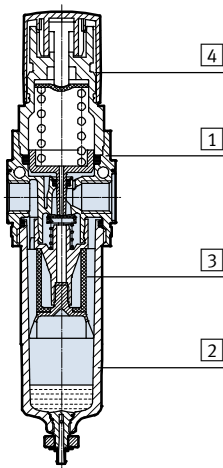

Filter regulator	Mini
1 Housing	PA-reinforced
2 Bowl	PC
3 Filter	PE
4 Rotary knob	POM
- Seals	NBR
Note on materials	RoHS-compliant

Standard flow rate q_n as a function of output pressure p_2

Operating pressure $p_1 = 10$ bar

Grade of filtration 5 μ m

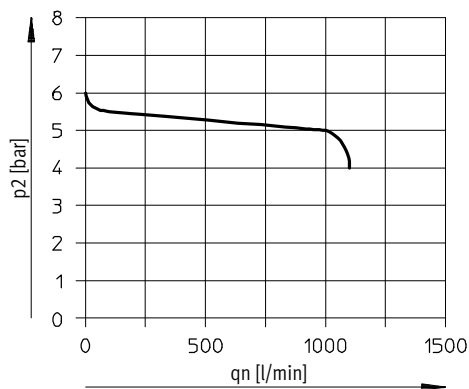

Grade of filtration 40 μ m

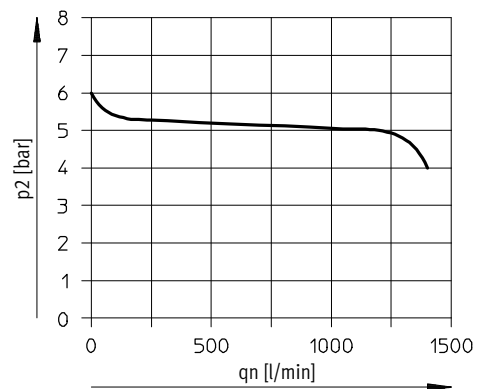

 Note
Slight leakage at the output has been taken into account in the design. It improves the control behaviour of the non pre-pressure compensated controller. In a few cases leakage may amount to 500 l/h.

Filter regulators LFR, D series, polymer

Technical data

FESTO

Dimensions

Download CAD data → www.festo.com

Mini

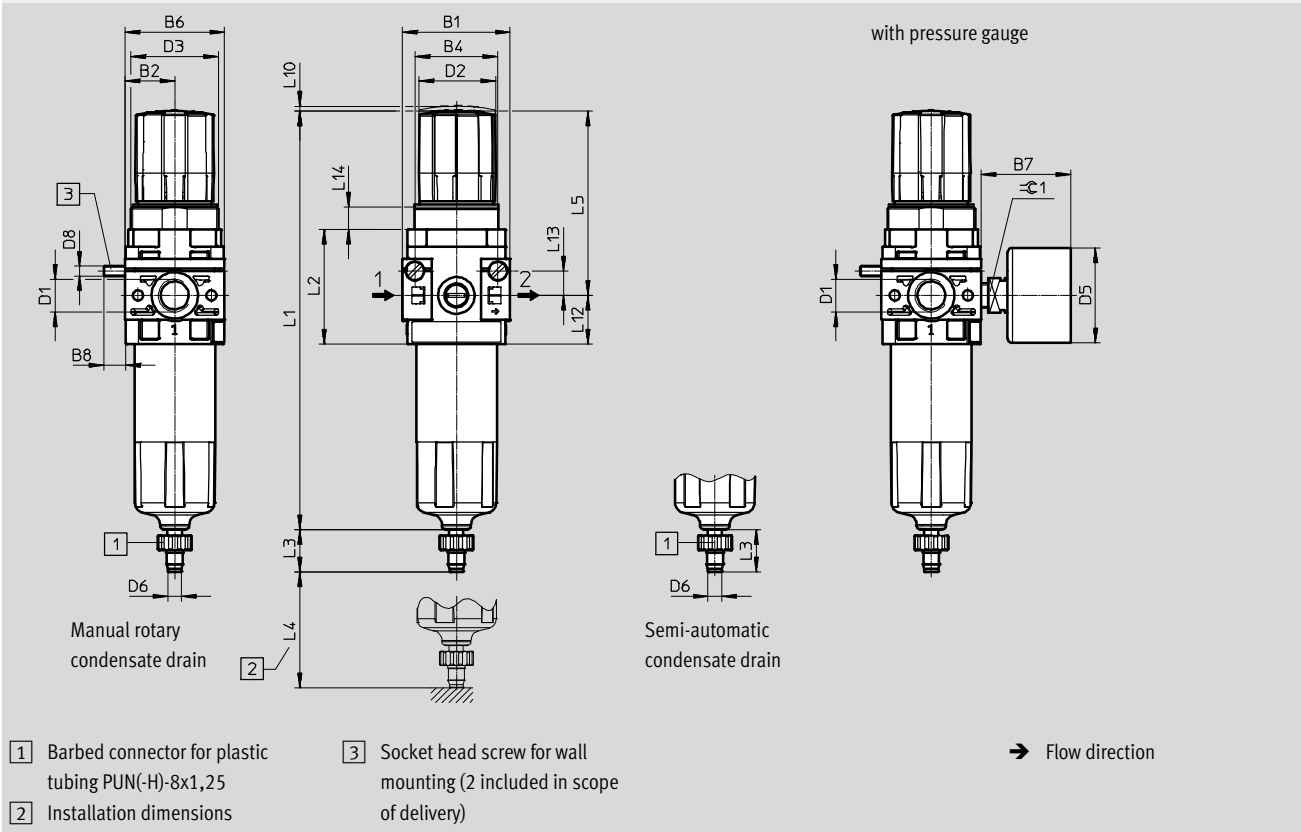

Type	B1	B2	B4	B6	B7 max.	B8	D1	D2 ∅	D3	D5 ∅	D6 ∅	D8
LFR-¼-DB	44	20.5	34	41	37	9	G¼	32	M36x1.5	39	5.6	M4

Type	L1	L2	L3	L4 min.	L5	L10	L12	L13	L14	≈1
LFR-¼-DB	171.7	47	17.3	60	76	2	20	10	9	14

Ordering data

Pressure regulation range 0.5 ... 7 bar

Condensate drain	Size	Connection	Grade of filtration 5 µm		Grade of filtration 40 µm	
			Part No.	Type	Part No.	Type

With pressure gauge, outer scale in bar, inner scale in psi

Manual rotary	Mini	G¼	539689	LFR-¼-DB-7-5M-MINI	539685	LFR-¼-DB-7-MINI
Semi-automatic	Mini	G¼	539690	LFR-¼-DB-7-5M-MINI-H	539686	LFR-¼-DB-7-MINI-H

Without pressure gauge

Manual rotary	Mini	G¼	537644	LFR-¼-DB-7-5M-O-MINI	537647	LFR-¼-DB-7-O-MINI
Semi-automatic	Mini	G¼	537646	LFR-¼-DB-7-5M-O-MINI-H	537645	LFR-¼-DB-7-O-MINI-H

Filter regulators LFR/LFRS, D series

Accessories

FESTO

Filter cartridges, D series, metal design



Ordering data			
Size	Grade of filtration [µm]	Part No.	Type
Micro	5	526818	LFP-D-MICRO-5M
Mini	5 (colour: blue)	159640	LFP-D-MINI-5M
	40 (colour: white)	363665	LFP-D-MINI-40M
Midi	5 (colour: blue)	159594	LFP-D-MIDI-5M
	40 (colour: white)	363667	LFP-D-MIDI-40M
Maxi	5 (colour: blue)	159641	LFP-D-MAXI-5M
	40 (colour: white)	363664	LFP-D-MAXI-40M

Filter cartridges, D series, polymer





Ordering data			
Size	Grade of filtration [µm]	Part No.	Type
Mini	5	547957	LFP-DB-MINI-5M
	40	534502	MS4-LFP-E

Filter regulators LFR/LFRS, D series

Accessories

FESTO

Ordering data – Pressure gauge MA						
	Nominal size	Pneumatic connection	Indicating range		Part No.	Type
			[bar]	[psi]		
	Pressure gauge MA					Technical data → Internet: ma
	27	M5	0 ... 10	–	526323	MA-27-10-M5
	40	G $\frac{1}{8}$	0 ... 10	0 ... 145	359874	MA-40-10-$\frac{1}{8}$
			0 ... 16	0 ... 232	345395	MA-40-16-$\frac{1}{8}$
	50	G $\frac{1}{4}$	0 ... 10	0 ... 145	359873	MA-50-10-$\frac{1}{4}$
			0 ... 16	0 ... 232	356759	MA-50-16-$\frac{1}{4}$
	Pressure gauge MA, DIN EN 837-1					Technical data → Internet: ma
	40	R $\frac{1}{8}$	0 ... 10	0 ... 145	162835	MA-40-10-$\frac{1}{8}$-EN
		G $\frac{1}{4}$	0 ... 10	0 ... 145	183900	MA-40-10-G$\frac{1}{4}$-EN
	Flanged pressure gauge FMA, DIN EN 837-1					Technical data → Internet: fma
40	G $\frac{1}{4}$	0 ... 10	0 ... 145	159596	FMA-40-10-$\frac{1}{4}$-EN	
		0 ... 16	0 ... 232	159597	FMA-40-16-$\frac{1}{4}$-EN	
50	G $\frac{1}{4}$	0 ... 10	0 ... 145	159599	FMA-50-10-$\frac{1}{4}$-EN	
		0 ... 16	0 ... 232	159600	FMA-50-16-$\frac{1}{4}$-EN	

Ordering data – Pressure sensor SPAU						
	Pneumatic connection	Switching output	Display type	Electrical connection	Part No.	Type
	Male thread R $\frac{1}{8}$	2x PNP or 2x NPN, switchable	Illuminated LCD	M8x1, 4-pin	8001203	SPAU-P10R-T-R18M-L-PNLK-PNVBA-M8D
				M12x1, 4-pin	8001206	SPAU-P10R-T-R18M-L-PNLK-PNVBA-M12D
	Male thread R $\frac{1}{4}$			M8x1, 4-pin	8001209	SPAU-P10R-T-R14M-L-PNLK-PNVBA-M8D
				M12x1, 4-pin	8001208	SPAU-P10R-T-R14M-L-PNLK-PNVBA-M12D

Festo North America

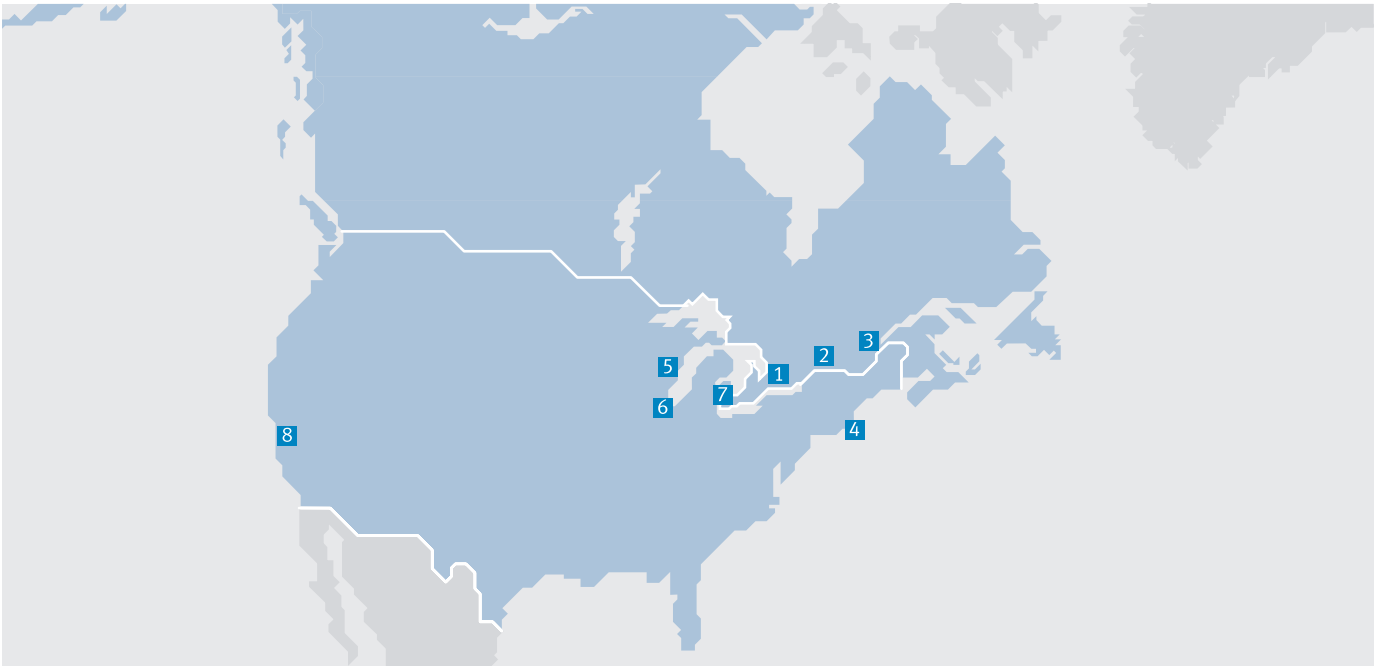

**1 Festo Canada
Headquarters
Festo Inc.**
5300 Explorer Drive
Mississauga, ON
L4W 5G4

2 Montréal
5600, Trans-Canada
Pointe-Claire, QC
H9R 1B6

3 Québec City
2930, rue Watt#117
Québec, QC
G1X 4G3



**4 Festo United States
Headquarters
Festo Corporation**
395 Moreland Road
Hauppauge, NY
11788

5 Appleton
North 922 Tower View Drive, Suite N
Greenville, WI
54942

7 Detroit
1441 West Long Lake Road
Troy, MI
48098

6 Chicago
85 W Algonquin - Suite 340
Arlington Heights, IL
60005

8 Silicon Valley
4935 Southfront Road, Suite F
Livermore, CA
94550

Festo Regional Contact Center

Canadian Customers

Commercial Support:
Tel: 1 877 GO FESTO (1 877 463 3786)
Fax: 1 877 FX FESTO (1 877 393 3786)
Email: festo.canada@ca.festo.com

Technical Support:
Tel: 1 866 GO FESTO (1 866 463 3786)
Fax: 1 877 FX FESTO (1 877 393 3786)
Email: technical.support@ca.festo.com

USA Customers

Commercial Support:
Tel: 1 800 99 FESTO (1 800 993 3786)
Fax: 1 800 96 FESTO (1 800 963 3786)
Email: customer.service@us.festo.com

Technical Support:
Tel: 1 866 GO FESTO (1 866 463 3786)
Fax: 1 800 96 FESTO (1 800 963 3786)
Email: product.support@us.festo.com